

4

3

2

1

REVISIONS				
ZONE	REV	DESCRIPTION	DATE	APPROVED
	A	RELEASED FOR PRODUCTION	4/1/11	BS
	B	ADDED MOUNTING SPACERS	10/3/11	BS

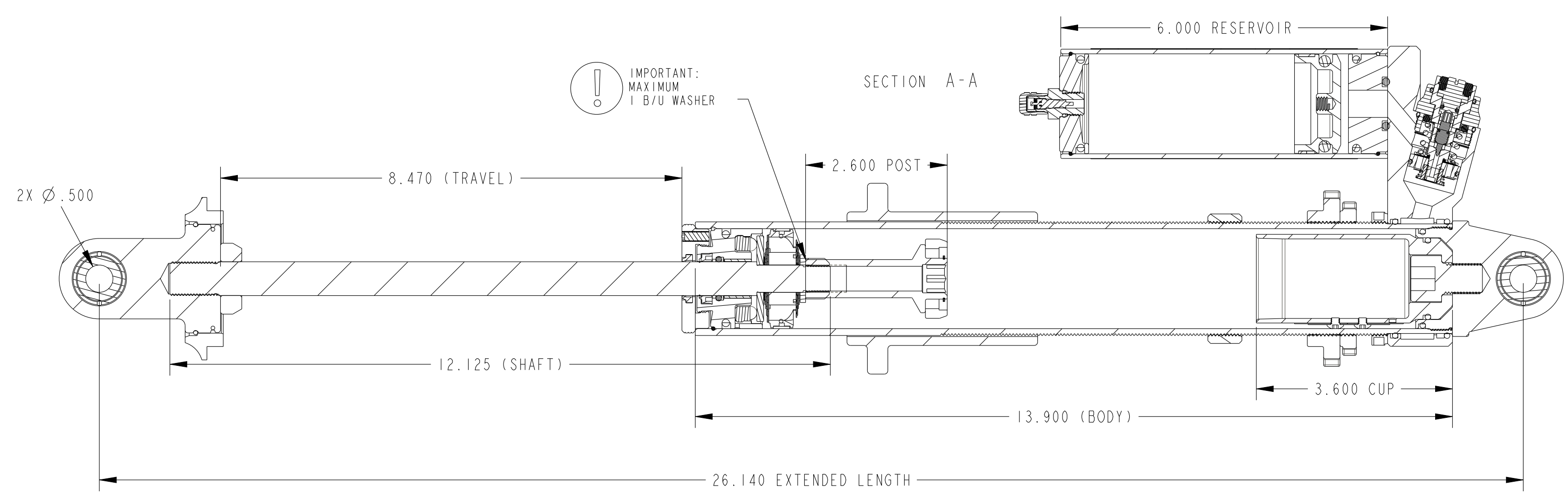
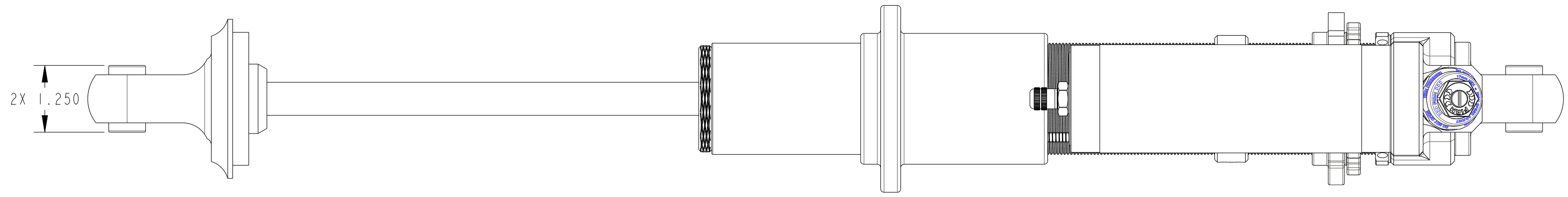

- NOTES:
1. VALVING: 80/80 (2X .070 BLEED)
 2. PISTON: 222-10-000-A
 3. OIL: RED
 4. MOUNTING: SPACER KIT (FOX P/N: 803-00-030-A)

- PROPRIETARY -
THIS DOCUMENT CONTAINS CONFIDENTIAL, PROPRIETARY INFORMATION
THAT IS FOX PROPERTY. DO NOT DISCLOSE TO OR DUPLICATE
FOR OTHERS EXCEPT AS AUTHORIZED BY FOX.

UNLESS OTHERWISE SPECIFIED DIMENSIONS ARE IN: INCHES [MM]		PER ASME Y14.5M 1994		FOX Factory, Inc. <small>130 Hangar Way, Watsonville, CA 95076 USA Ph 831-768-1100 Fax 831-768-9312</small>	
TOLERANCES ARE:		APPROVALS	DATE	TITLE	
DECIMALS	ANGLES	DWN. BY		8.47", Ø0.625 C/O, P/B,	
.XX [.X] ± .01 [0,25]	± 1°	B SMITH	01-Apr-11	2.0 SERIES B/O CUP, DSC	
.XXX [.XX] ± .005 [0,13]		CHK. BY		SIZE DWG. NO.	
THIRD ANGLE PROJECTION		ENG.		C 983-06-003	
 DO NOT SCALE DRAWING		MFG.		PLOT SCALE 0.60:1	
		ADD.		SHEET 1 OF 1	

4

3

2

1